

KB6260TR 6V 260Ah



Kaise motive power batteries are mainly used in electric bicycles, electric tricycles, low-speed electric cars, golf carts and sightseeing carts. The products are mainly supplied to the mainstream manufacturers in the industry.

Performance Characteristics

Nominal Voltage	6V	
Dimensions	Length (mm / inch)	260 / 10.24
	Width (mm / inch)	180 / 7.09
	Height (mm / inch)	248 / 9.76
	Total Height (mm / inch)	279.5 / 11.0
Approx Weight	(Kg / lbs)	23.2 / 51.1
Terminal	M8	
Container Material	PP	
Rated Capacity	260Ah / 13.0A	(20hr, 1.75V / cell, 25°C / 77°F)
	215Ah / 43.0A	(5hr, 1.75V / cell, 25°C / 77°F)
Reserve Capacity	25Amps	530min
	75Amps	145min

Charge Method

Initial Charge:

- ① 0.1C₂₀(A) charging 15h
- ② 0.05C₂₀(A) charging 10h

The temperature of the battery should be below 50°C during charging.

Supplement Charge:

- a) Charging at a constant voltage of 7.35~7.5V/cell and a limited current 0.25C₂₀ (A) until the electrolyte density up to 1.280g/cm³ (30°C) and the current not change for 3 hours.
- b) Charge with constant current 0.1C₂₀ (A) until the voltage between 7.8~8.4V/cell, and voltage maintains for 3 hours and not change.
Two method optional.

Cycle Life in Relation to Depth of Discharge

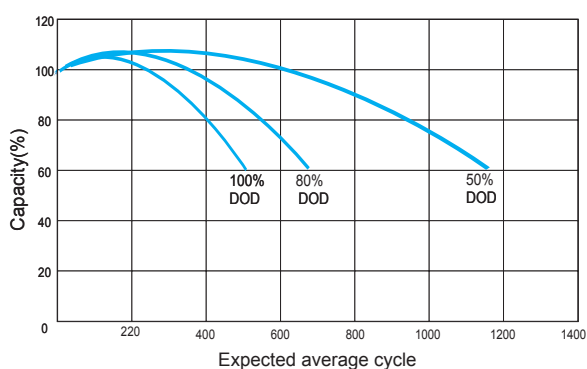

Dimensions and Terminal (Unit: mm (inches))

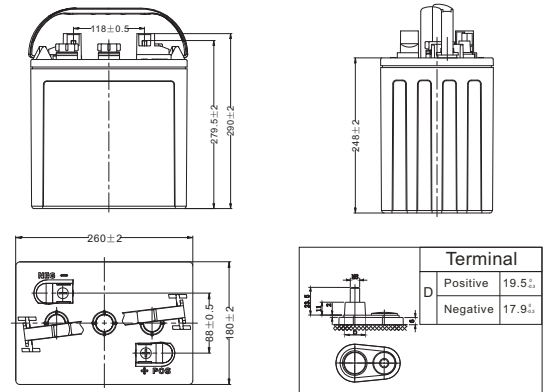

Applications

- Electric bicycles
- Electric tricycles
- Electric cars
- Golf Carts
- Sightseeing Carts

Certifications

ISO 9001 / ISO 14001



Discharge Characteristics (25°C, 77°F)

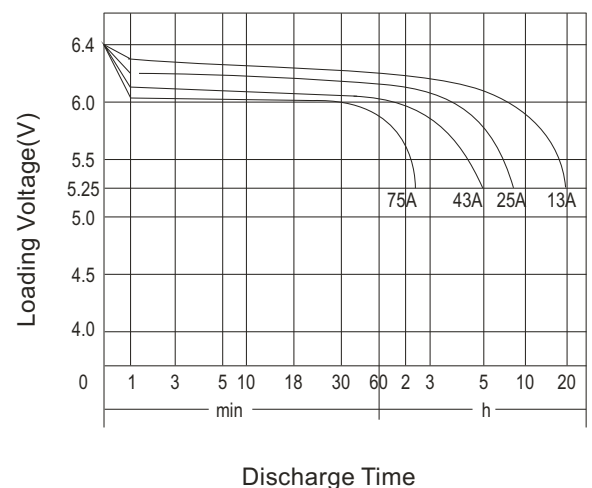

(Note) The above characteristics data are average values obtained within three charge/discharge cycles not the minimum values.