

KB8170TR 8V 170Ah



Kaise motive power batteries are mainly used in electric bicycles, electric tricycles, low-speed electric cars, golf carts and sightseeing carts. The products are mainly supplied to the mainstream manufacturers in the industry.



Performance Characteristics

Nominal Voltage	8V	
Dimensions	Length (mm / inch)	260 / 10.24
	Width (mm / inch)	180 / 7.09
	Height (mm / inch)	248 / 9.76
	Total Height (mm / inch)	279.5 / 11.0
Approx Weight	(Kg / lbs) 28.2 / 62.2	
Terminal	M8	
Container Material	PP	
Rated Capacity	170Ah / 8.5A	(20hr, 1.75V / cell, 25°C / 77°F)
	145h / 29A	(5hr, 1.75V / cell, 25°C / 77°F)
Reserve Capacity	25Amps	295min
	56Amps	117min

Charge Method

Initial Charge:

- ① 0.1C₂₀ (A) charging 15h
- ② 0.05C₂₀ (A) charging 10h

The temperature of the battery should be below 50°C during charging.

Supplement Charge:

- a) Charging at a constant voltage of 9.8~10V/cell and a limited current 0.25C₂₀(A) until the electrolyte density up to 1.280g/cm³(30°C) and the current not change for 3 hours.
- b) Charge with constant current 0.1C₂₀(A) until the voltage between 10.4~11.2V/cell, and voltage maintains for 3 hours and not change.
Two method optional.

Cycle Life in Relation to Depth of Discharge

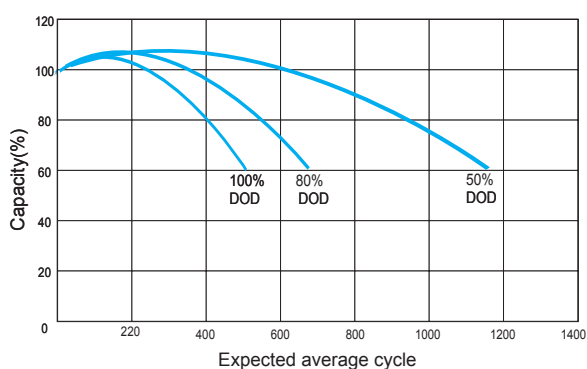

Dimensions and Terminal (Unit: mm (inches))

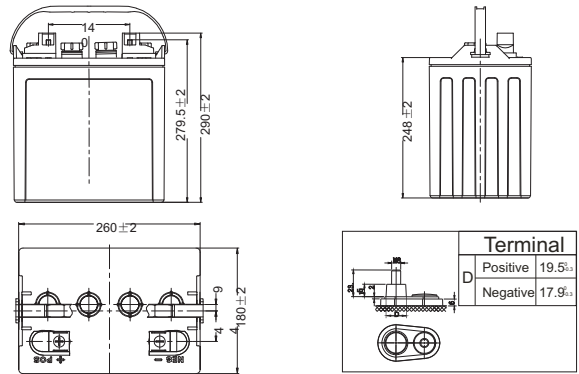

Applications

- Electric bicycles
- Electric tricycles
- Electric cars
- Golf Carts
- Sightseeing Carts

Certifications

ISO 9001 / ISO 14001



Discharge Characteristics (25°C, 77°F)

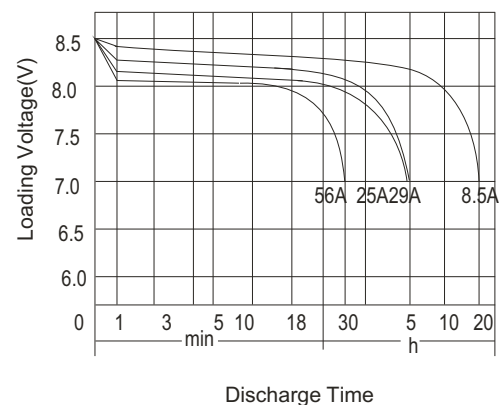

(Note) The above characteristics data are average values obtained within three charge/discharge cycles not the minimum values.