

# KB1272 12V 7.2Ah



The KB Standard series consists in VRLA batteries - AGM technology (Absorbent Glass Mat), with a design life of 6-8 years and it is designed for general applications such as UPS, telecommunications and electrical applications.



## Performance Characteristics

Nominal Voltage	12V		
Dimensions	Length (mm / inch)	151 / 5.94	
	Width (mm / inch)	65 / 2.56	
	Height (mm / inch)	94 / 3.70	
	Total Height (mm / inch)	100 / 3.94	
Approx Weight	(Kg / lbs)	2.15 / 4.74	
Design Life	6-8 years (Float charging)		
Terminal	F2		
Container Material	A.B.S. UL94-HB, UL94-V0 Optional.		
Rated Capacity	7.26Ah / 0.363A	(20hr, 1.75V / cell, 25°C / 77°F)	
	6.93Ah / 0.693A	(10hr, 1.75V / cell, 25°C / 77°F)	
	6.31Ah / 1.261A	(5hr, 1.75V / cell, 25°C / 77°F)	
	4.593Ah / 4.593A	(1hr, 1.60V / cell, 25°C / 77°F)	
Max. Discharge Current	72A (5s)		
Internal Resistance	Approx 25mΩ		
Operating Temp. Range	Discharge : -20 ~ 60°C (-4 ~ 140°F)		
	Charge : 0 ~ 50°C (32 ~ 122°F)		
	Storage : -20 ~ 60°C (-20 ~ 140°F)		
Nominal Operating Temp. Range	25 ± 5°C (77 ± 41°F)		
Cycle Use	Initial Charging Current less than 2.16A		
	Voltage: 14.6V ~ 14.8V at 25°C (77°F)		
	Temp. Coefficient: -4mV/°C		
Standby Use	Initial Charging Current less than 2.16A		
	Voltage: 13.7V ~ 13.9V at 25°C (77°F)		
	Temp. Coefficient: -3mV/°C		
Capacity affected by Temperature	40°C (104°F)	103%	
	25°C (77°F)	100%	
	0°C (32°F)	86%	
Self Discharge	Fully charged Kaise Standard Series batteries may be stored for up to 6 months at 25°C (77°F) and then a freshening charge is required. For higher temperatures the time interval will be shorter.		

## Discharge Constant Current (Amperes) at 77°F (25°C)

Volts/cell	5min	10min	15min	30min	1h	3h	5h	10h	20h
1.80V	22.28	15.19	11.49	6.850	4.053	1.802	1.226	0.676	0.355
1.75V	24.45	16.39	12.29	7.241	4.247	1.863	1.261	0.693	0.363
1.70V	26.17	17.33	12.90	7.543	4.395	1.909	1.288	0.705	0.368
1.65V	27.52	18.06	13.37	7.774	4.508	1.944	1.309	0.714	0.372
1.60V	28.55	18.62	13.73	7.948	4.593	1.970	1.324	0.721	0.375

## Dimensions and Terminal (Unit: mm (inches))

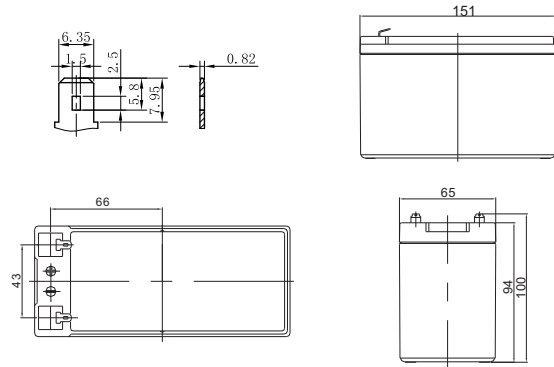

## Applications

- |                            |                                       |
|----------------------------|---------------------------------------|
| Alarm systems              | Marine equipment                      |
| Cable television           | Medical equipment                     |
| Communications Equipment   | Micro processor based office machines |
| Control Equipment          | Portable cine & Video lights          |
| Computers                  | Solar powered systems                 |
| Electronic Cash Registers  | Telecommunications systems            |
| Electric Test Equipment    | Television & Video recorders          |
| Emergency lighting systems | Toys                                  |
| Fire & Security            | Uninterruptible power supply systems  |
| Geophysical equipment      | Vending machines                      |

## Certifications

ISO 9001/ ISO 14001



## Discharge Current vs. Discharge Voltage

Final discharge voltage V/CELL	1.8	1.75	1.7	1.6
Discharge current [A]	$I \leq 0.1CA$	$0.25CA \geq I > 0.1CA$	$0.55CA \geq I > 0.25CA$	$I > 0.55CA$

## Discharge Constant Power (Watts per cell) at 77°F (25°C)

Volts/cell	5min	10min	15min	30min	1h	3h	5h	10h	20h
1.80V	41.22	28.18	21.61	13.15	7.88	3.55	2.43	1.36	0.71
1.75V	44.47	29.89	22.78	13.77	8.21	3.66	2.49	1.39	0.73
1.70V	46.76	31.04	23.58	14.19	8.46	3.73	2.54	1.41	0.74
1.65V	48.62	31.99	24.23	14.55	8.64	3.79	2.57	1.43	0.74
1.60V	49.13	32.12	24.37	14.65	8.72	3.82	2.59	1.44	0.75

(Note) The above characteristics data are average values obtained within three charge/discharge cycles not the minimum values.

## Charging Characteristics (float use)

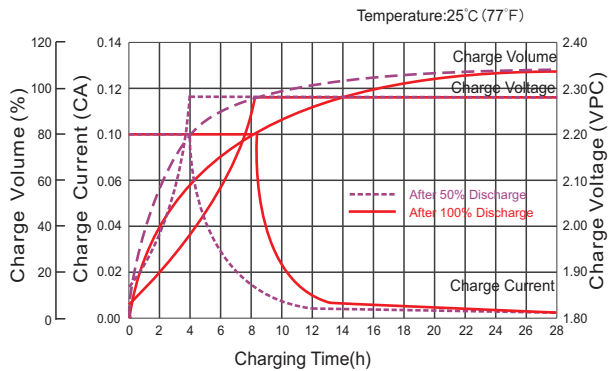

## Discharge Characteristics Curve

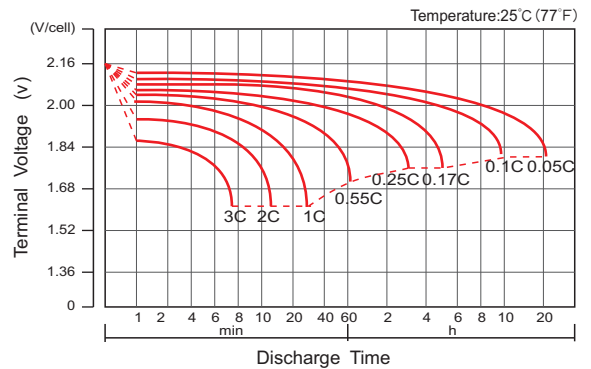

## Cycle Life In Relation To Depth Of Discharge

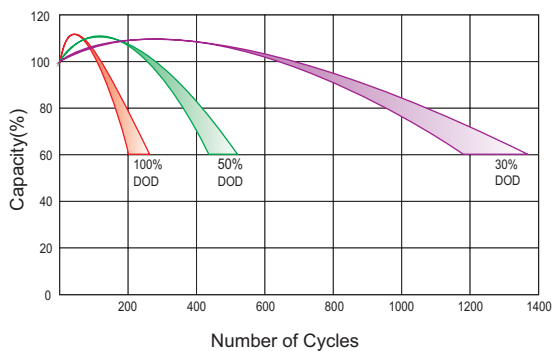

## Relationship Between Charging Voltage And Temperature

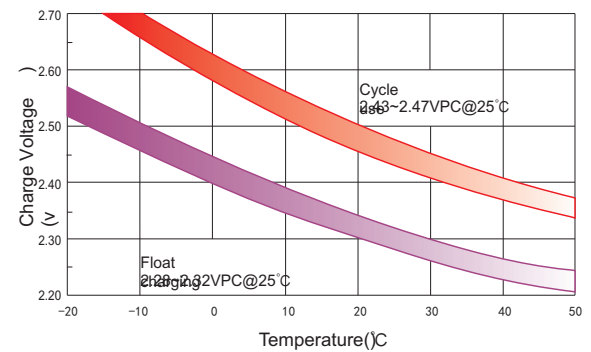

## Temperature Effects On Capacity

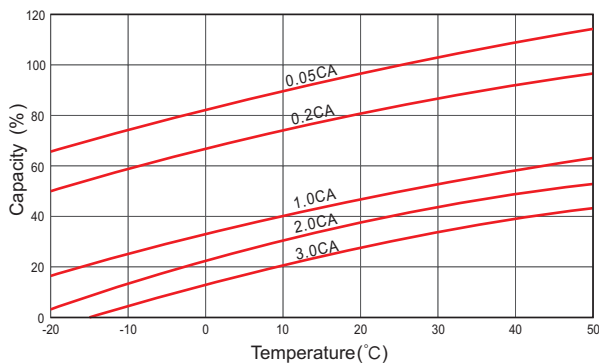

## Storage Characteristics

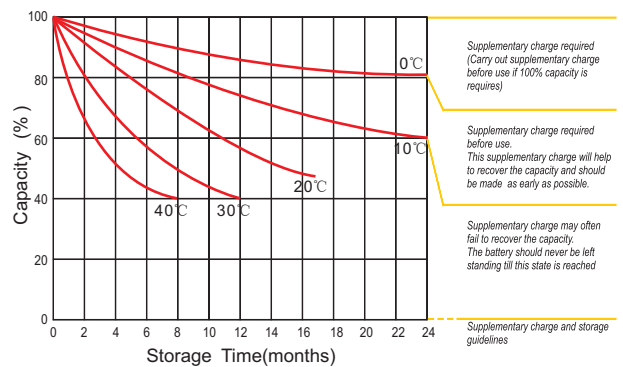

## Effect Of Temperature On Long Term Life

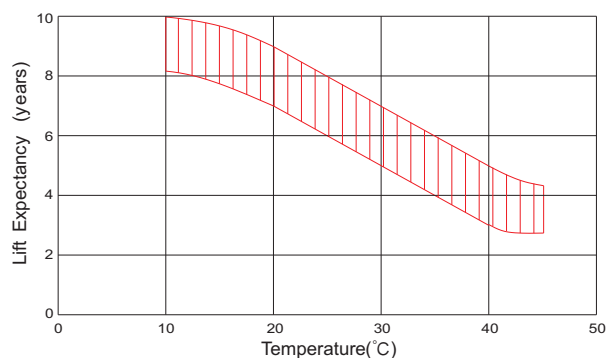

## Life Characteristics Of Standby Use

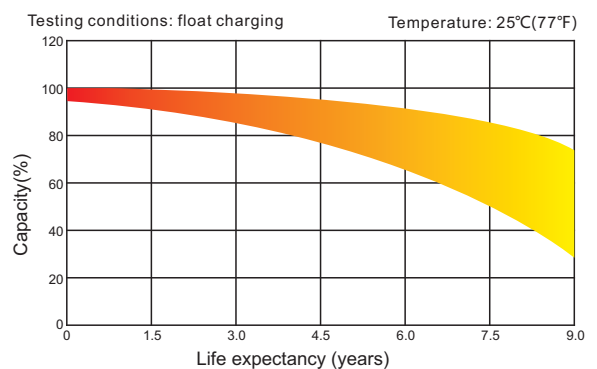

IMPORTANT NOTE: The specifications presented herein are subject to revision without notice.

